

**Quick Installation Guide**  
**SG33CX/SG40CX**  
**SG50CX**  
**PV Grid-connected Inverter**

SG33\_40\_50CX-QIEN-Ver10-201904 Version: 1.0



This guide is valid for inverters SG33CX, SG40CX and SG50CX, providing the installation, electrical connection, commissioning and troubleshooting procedure.

**⚠ NOTICE**

- Contents may be periodically updated or revised due to product development, The information in this guide is subject to change without notice. In no case shall this guide substitute for the user manual or related notes on the device.
- Make sure to read over, fully understand and strictly follow the detailed instructions of the user manual and other related regulations before installing the equipment.
- All operations can be performed only by qualified personnel, that must be trained in the installation and commissioning of the electrical system, as well as the dealing with hazards, have knowledge of the manual and of the local regulations and directives.
- Before installation, check that the package contents are intact and complete against the packing list. Contact SUNGROW or the distributor in case of any damaged or missing components.
- The cable must be intact and well insulated. Operation personnel must wear proper personal protective equipment (PPE) all the time.
- Any violation could result in personal death or injury or device damage, and will avoid the warranty.

# 1 Product Introduction

## 1-1 Appearance

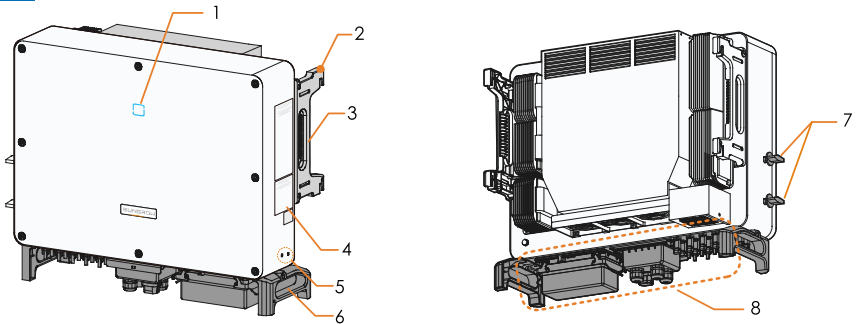

1. LED indicator    2. Mounting ear    3. Side handles    4. Warning symbols, nameplate, and QR code  
 5. Additional grounding terminals    6. Bottom handles    7. DC switches    8. Wiring area

## 1-2 Dimensions

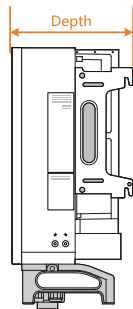
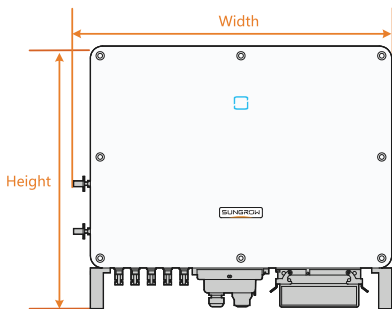

| Type   | (WxHxD)          | Weight |
|--------|------------------|--------|
| SG33CX | 702x595x310 (mm) | 50kg   |
| SG40CX | 782x645x310 (mm) | 58kg   |
| SG50CX | 782x645x310 (mm) | 62kg   |

\*The image shown here is for reference only. The actual product you receive may differ.

## 2 Mechanical Mounting

### 2-1 Location Selection

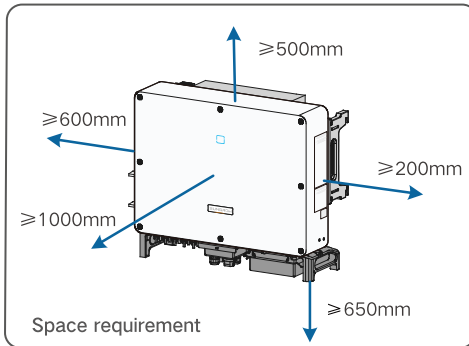
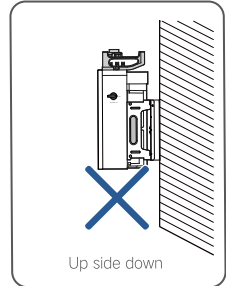
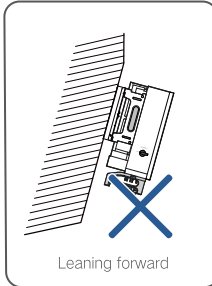
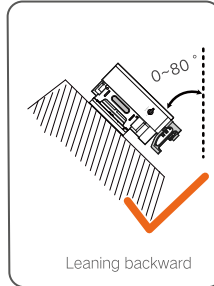
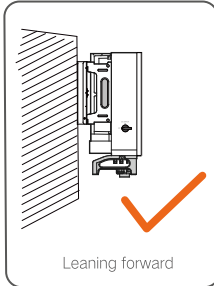
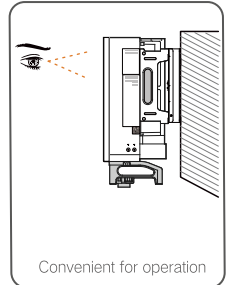
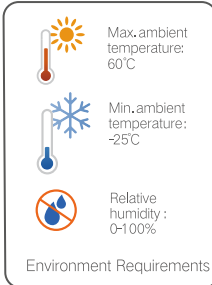
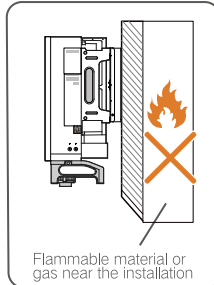
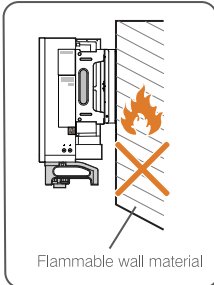

### 2-2 Installation

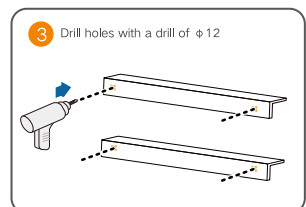
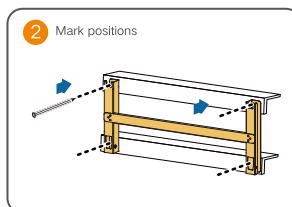
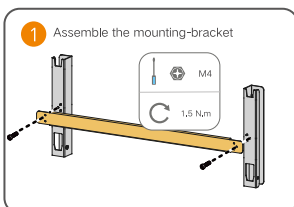

**4** Secure the mounting-bracket with M10 bolts

Fastening sequence

- A: Mounting-bracket
- B: Full threaded bolt
- C: Metal bracket
- D: Flat washer
- E: Spring washer
- F: Hex nuts

**5** Hang the inverter to the mounting-bracket

**6** Fix the inverter with M6 x 65 screws

## 3 Electrical Connection

### Overview

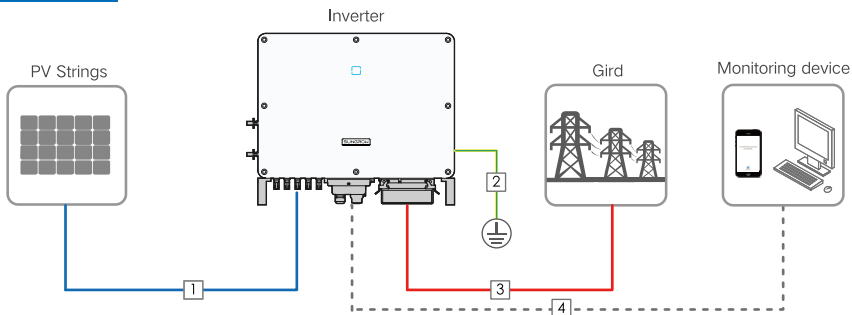

### 3-1 Cable requirements

| No | Cable                      | Type  | Outer diameter(mm) | Cross section(mm <sup>2</sup> )  |
|----|----------------------------|---|--------------------|--|
| 1  | DC cable                   | PV cable complying with 1,500V standard                               | 6-9                | 4-6  |
| 2  | Additional grounding cable | Outdoor single-core copper wire cable                                 | /                  | The same as that of the PE wire in the AC cable  |
| 3  | AC cable                   | Outdoor multi-core copper or aluminium cable                          | 20-50              | Phase wire (SG33CX): 16-35<br>Phase wire (SG40CX): 25-50<br>Phase wire (SG50CX): 35-70<br>PE wire:<br>Depends on phase wire cross-section S,<br>When 16 < S ≤ 35, it is 16,<br>When S > 35, it is S/2. |
| 4  | Communication cable        | Shielded twisted pair (terminal block)<br>CAT-5 Ethernet cable (RJ45) | 4,5-18             | 1-1,5<br>/   |

### ⚠ NOTICE

- The DC cable must be a multi-core cables.

## 3-2 Additional Grounding Connection

### ⚠ NOTICE

- Since the inverter is a transformerless inverter, neither the negative pole nor the positive pole of the PV string can be grounded. Otherwise, the inverter will not operate normally.
- There are two terminals. Use at least one of them to ground the inverter.

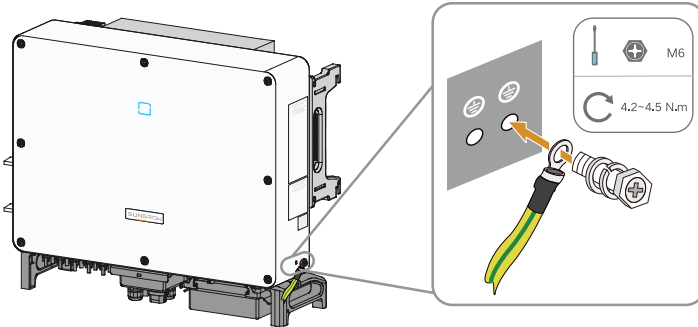

## 3-3 AC Connection

### ⚠ NOTICE

- Before connecting the inverter to the grid, ensure the grid voltage and frequency comply with requirements.
- Disconnect the AC-side circuit breaker and prevent it from inadvertent reconnection.
- Observe the pin assignment of AC terminal block. If a phase wire is connected to the "PE" terminal, it may permanently damage the inverter.
- Please avoid squeezing the cable insulation layer into the AC terminal. Improper connection may affect the normal operation of the inverter.
- During AC cable connection, the cables inside the lower part of the device should be bended to be surplus in length. In this way, cable drooping or loosening, which can cause arc or other problems impairing functionality of the device, due to self-weight of the cables in case of land subsidence is avoided.

- 1 Take out the AC wiring box and loosen the screw. Lead the cable through the swivel nut, seal, and wiring box successively.

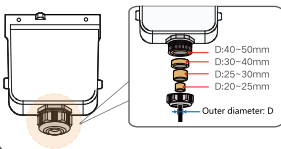

- 2 Strip the protection layer and insulation layer

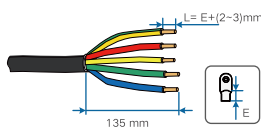

- 3 Install the heat shrink tubing and cable lug

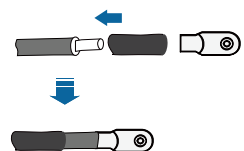

- 4 Crimp the cable lug

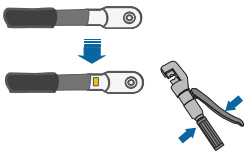

- 5 Fixed heat shrink tubing

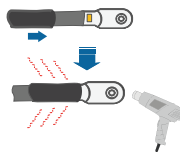

- 6 Unfasten the buckle and remove the protective cap

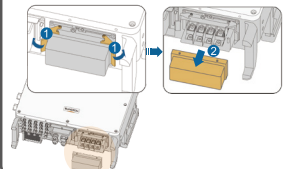

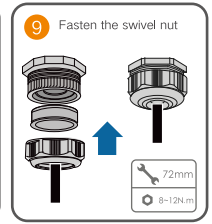
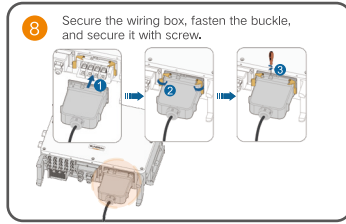
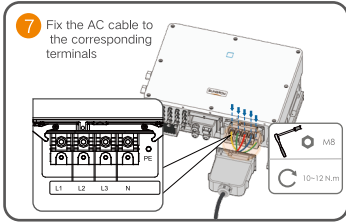

## 3-4 DC connection

### ⚠ NOTICE

- Use the MC4 DC terminal within the scope of delivery. Damage to the device due to the use of incompatible terminal shall not be covered by the warranty.
- There is a risk of inverter damage! The following requirements should be met. Failure to do so will void guarantee and warranty claims.
  - (1) Ensure that the open circuit voltage in any case does not exceed the inverter input upper limit of 1100V.
  - (2) Make sure the maximum short circuit current on the DC side is within the permissible range.
  - (3) Make sure the to-ground insulation performance of the PV string is sound.
- The inverter will not function properly if the DC polarities are reversed.
- If the PV connectors are not assembled into place, it may cause an arc or overheat. The loss caused by this issue will void the warranty.

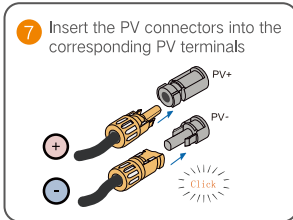
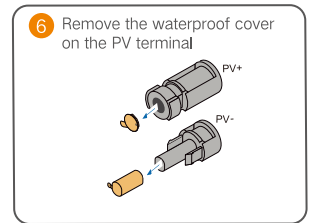
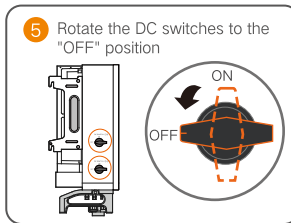
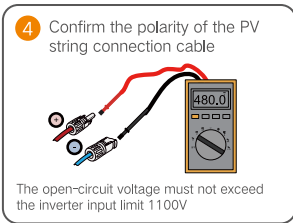
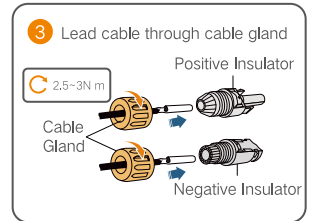
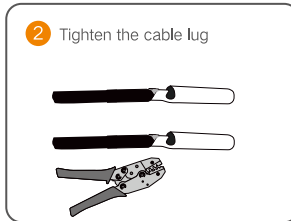
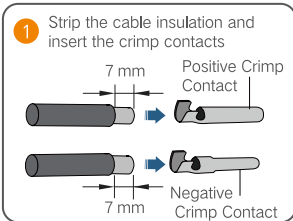

## 3-5 RS485 Communication Connection

As shown in the figure below, the inverter is equipped with three RS485 communication interfaces and one dip switch.

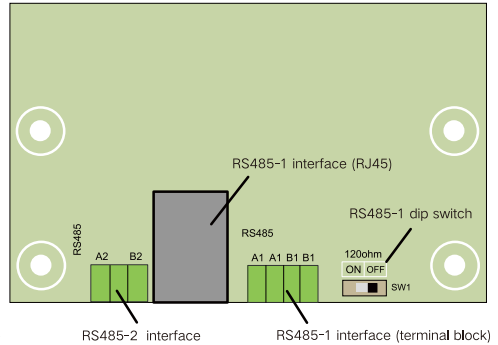
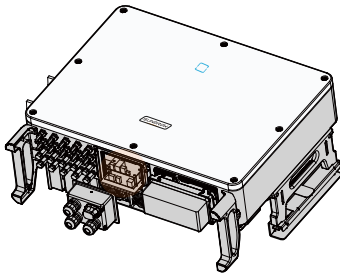

**i** RS485-1 terminal block interface and RJ45 interface serve as the same function with wiring manner different.

All the three interfaces can be connected to a data acquisition device (Logger), to achieve data exchange with PC or other monitoring devices. Multiple inverters can be connected in the daisy chain manner via the RS485-1 terminal block and RJ45 terminal. A 120Ω resistor can be connected in parallel between RS485-1 A/B pins by configuring the dip switch.

### 3-5-1 Communication junction box

#### Removal

Pull out the pin, and remove the wiring box.

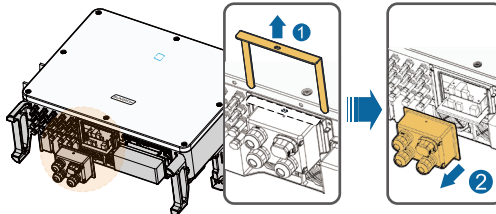

#### Installation

Remount the wiring box and press it tightly, insert the pin, and secure the wiring box with the supplied M4 × 25 screw.

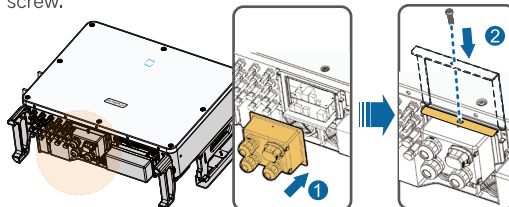

**i** During installation, press the junction box forcibly to ensure that the pin can be inserted successfully.

## 3-5-2 Connection Procedure

### Terminal Block

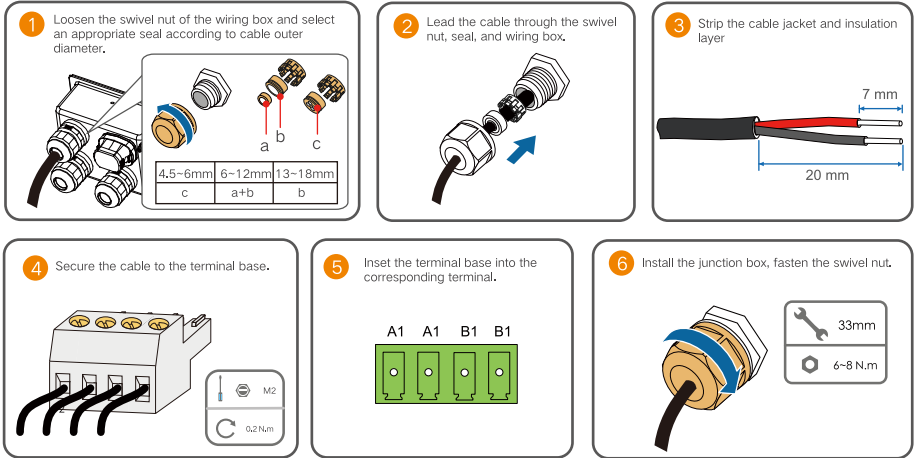

\*The image shown here is for reference only. Please wire according to the actual terminal definition.

### RJ45

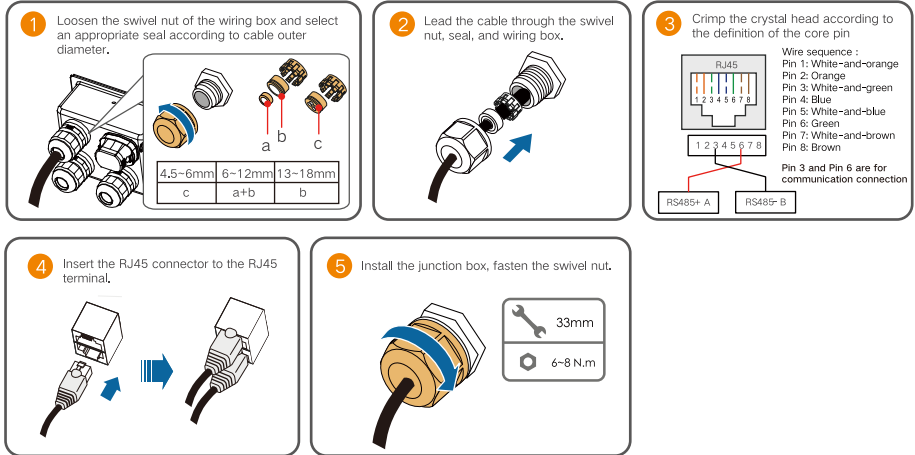

### ⚠ NOTICE

- There are three communication terminal, and the silk screen marks are COM1/COM3/COM4. Please choose according to the actual situation.



# 4 Commission

## 4-1 Inspection before Commissioning

| No. | Items  | Result                   |                          |
|-----|--|--------------------------|--------------------------|
|     |  | Yes                      | No                       |
| 1   | The inverter should be accessible for operation, maintenance and service.        | <input type="checkbox"/> | <input type="checkbox"/> |
| 2   | The inverter is firmly installed.  | <input type="checkbox"/> | <input type="checkbox"/> |
| 3   | Nothing is left on the top of the inverter.                                      | <input type="checkbox"/> | <input type="checkbox"/> |
| 4   | The inverter is correctly connected to the external devices.                     | <input type="checkbox"/> | <input type="checkbox"/> |
| 5   | The cables are routed in a safe place or protected against mechanical damage.    | <input type="checkbox"/> | <input type="checkbox"/> |
| 6   | The specification of the AC circuit breaker is appropriate for its intended use. | <input type="checkbox"/> | <input type="checkbox"/> |
| 7   | All unused terminals at the bottom of the inverter are properly sealed.          | <input type="checkbox"/> | <input type="checkbox"/> |
| 8   | Warning signs & labels are suitably affixed and durable.                         | <input type="checkbox"/> | <input type="checkbox"/> |

## 4-2 Commissioning Procedure

**Step1** Rotate the DC switch to the “ON” position.

**Step2** Connect the AC switch (if applicable) between the inverter and the grid.

**Step3** Connect the DC switch (if applicable) between the inverter and the PV string.

**Step4** Set initial protection parameters via the iSolarCloud APP. If the irradiation and grid conditions meet requirements, the inverter will normally operate.

**Step5** Observe the LED indicator to ensure that the inverter operates normally.

### LED indicator description

|   |                      |  |
|---|----------------------|--|
|  | Steady blue          | The device is connected to the grid and operating normally.  |
|   | Flashing blue (fast) | The Bluetooth communication is connected and there is data communication. No inverter fault occurs.              |
|   | Flashing blue (slow) | The DC or AC side is powered on and the device is in standby or startup state (not feeding power into the grid). |
|   | Steady red           | A fault occurs and the device cannot connect to the grid.  |
|   | Flashing red         | The Bluetooth communication is connected and there is data communication. Fault occurs.                          |
|   | OFF                  | Both the AC and DC sides are powered down.   |

# 5 iSolarCloud

## 5-1 Brief Introduction

The iSolarCloud APP can establish communication connection to the inverter via the Bluetooth, thereby achieving near-end maintenance on the inverter. Users can use the APP to view basic information, alarms, and events, set parameters, or download logs, etc.

\*In case the communication module Eye or WiFi is available, the iSolarCloud APP can also establish communication connection to the inverter via the mobile data or WiFi, thereby achieving remote maintenance on the inverter.

## 5-2 Download and Install

**Method 1:** Scan the right QR code to download and install the APP.

**Method 2:** Download the APP through the following application stores:

- MyApp (Android, mainland China users)
- Google Play (Android, users other than mainland China ones)
- APP store (iOS)



## 5-3 Initialize protection parameter

### NOTICE

- To log in to the app, the following conditions must be met:
  - (1) The AC and DC sides or the AC side of the inverter is powered-on.
  - (2) The mobile phone is within 5m away from the inverter and there are no obstructions in between.
  - (3) The Bluetooth function of the mobile phone is enabled.

**Step1** After the installation is complete, click "Open" or click the phone desktop APP icon to open the app.



**Step2** Open the APP, after which the Bluetooth search screen pops up automatically, and select the to-be-connected inverter according to the SN on the nameplate of the inverter. The Bluetooth indicator gets on once the connection is established. Alternatively, tap "📄" to scan the QR code on the side of the inverter to establish Bluetooth connection.

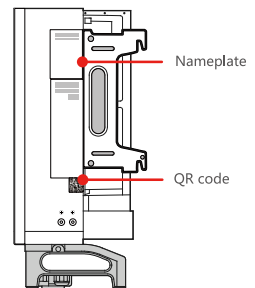
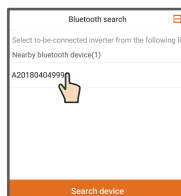
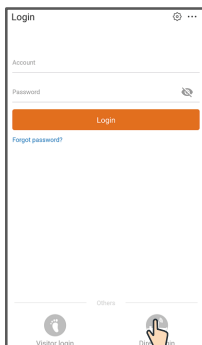

**Step3** Enter the username and login password, click Login and proceed to the next step.

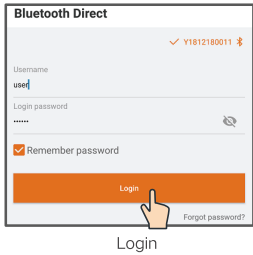

Login

**Step4** After logging in, enter the initialization protection parameter setting interface, as shown in the figure. After finishing setting on the quick setting screen, click “Boot” and the device will be initialized. The APP will send start instructions and the device will start and operate.



Initialization protection parameter

**NOTICE**

- The user name is "user" and the initial password is "pw1111". To ensure account security, please change the password as soon as possible.
- Reset the protection parameters if the country setting is incorrect. Otherwise, fault may occur.

**Step5** If the inverter is initialized, the APP automatically turns to its home page.

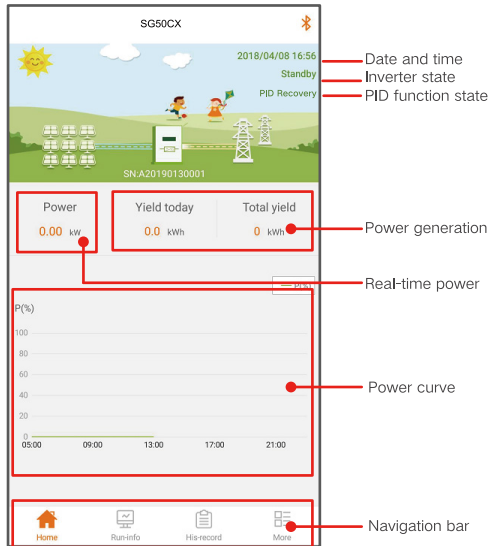

Home page

\*Screenshots in this manual are based on the Android system V2.1.4, and the actual interfaces may differ.

Sungrow Power Supply Co., Ltd.

Add: No. 1699 Xiyou Rd., New & High Technology Industrial Development Zone, 230088, Hefei, P. R. China.  
Web: [www.sungrowpower.com](http://www.sungrowpower.com)  
Tel: +86 551 6532 7834 / 6532 7845  
E-mail: [info@sungrow.cn](mailto:info@sungrow.cn)  
Fax: +86 551 6532 7856



More information in the QR code or  
at <http://support.sungrowpower.com/>

**SUNGROW**

Specifications are subject to changes without advance notice.



1411410011414